

株式会社トンボ鉛筆

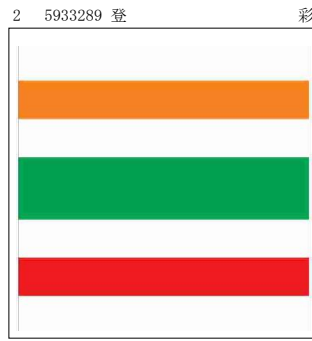

株式会社セブン-イレブン・ジャパン

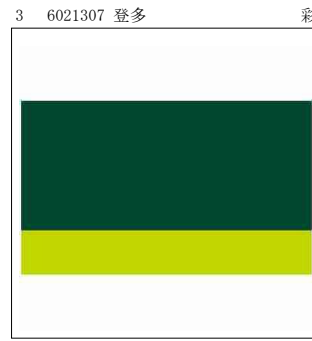

株式会社三井住友フィナンシャルグループ

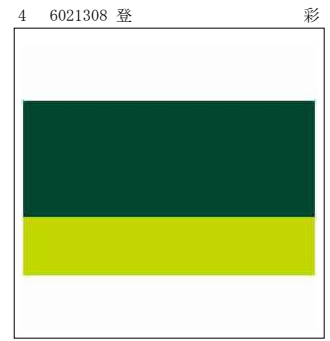

株式会社三井住友フィナンシャルグループ

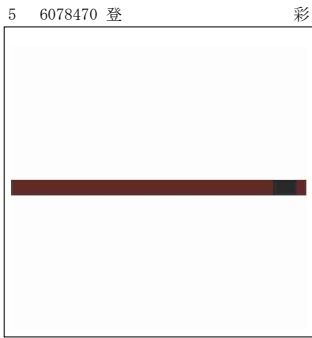

三菱鉛筆株式会社

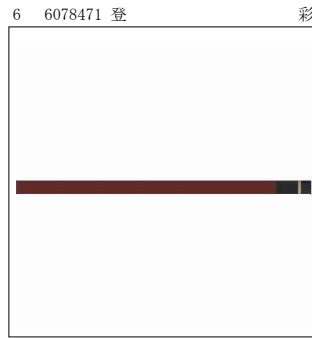

三菱鉛筆株式会社

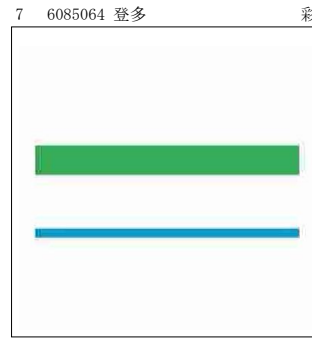

株式会社ファミリーマート

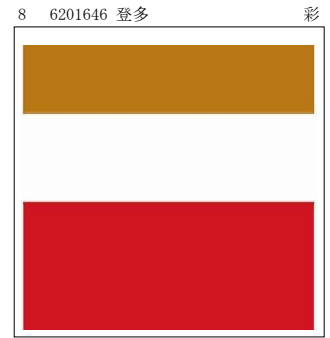

ユーシーシー上島珈琲株式会社

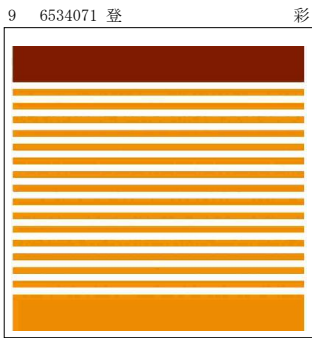

日清食品ホールディングス株式会社

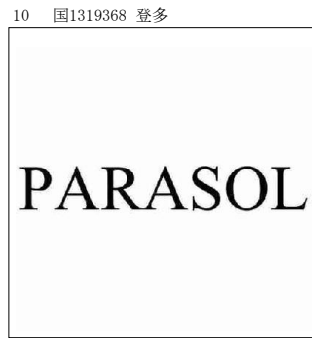

Parasol Co.



HOI NONG DAN VIET NAM TINH THAI NGUYEN

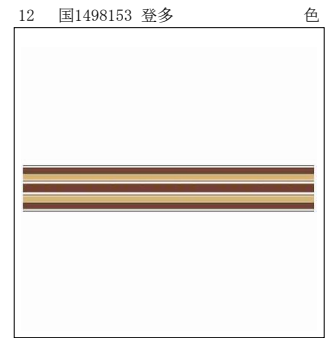

LORO PIANA S.p.A.



BUI QUOC CHAU



VISSAN JOINT STOCK COMPANY

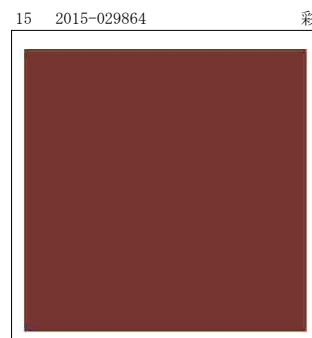

三菱鉛筆株式会社

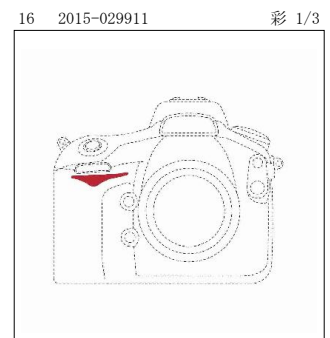

株式会社ニコン

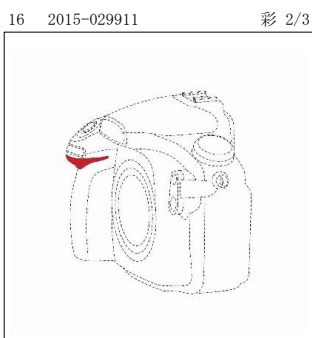

株式会社ニコン

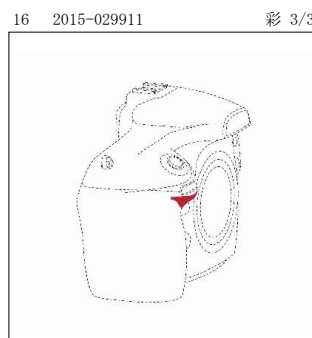

株式会社ニコン

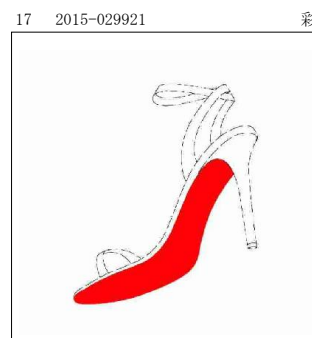

クリスチャン ルブタン

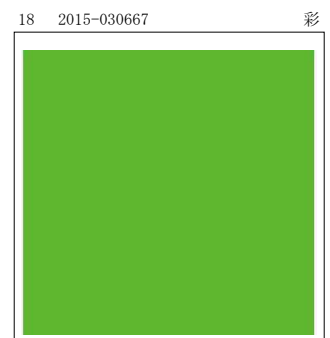

川崎重工株式会社

19 2015-030696 彩 1/2

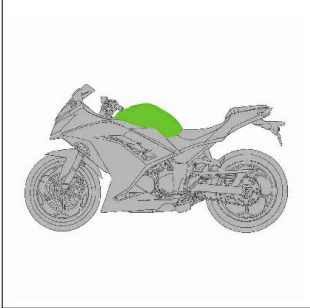

川崎重工業株式会社

19 2015-030696 彩 2/2

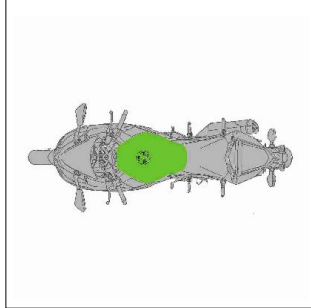

川崎重工業株式会社

20 2018-133223 多 彩

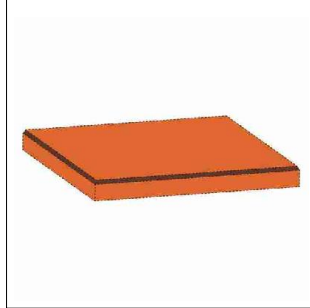

エルメス・アンテルナショナル

21 2018-162829 彩

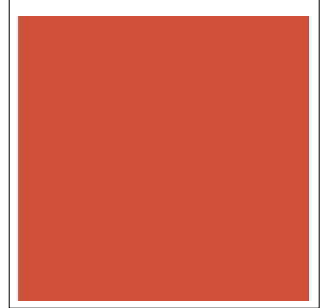

株式会社クボタ

22 2018-162832 彩



株式会社クボタ

23 2018-162834 彩

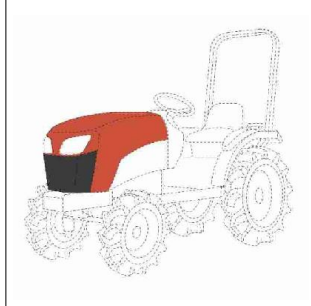

株式会社クボタ

24 2018-162836 彩

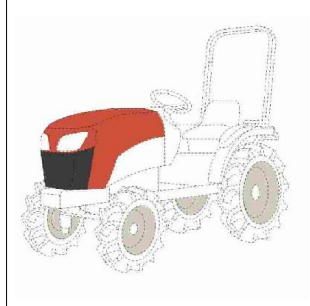

株式会社クボタ

25 2019-104386 多 彩

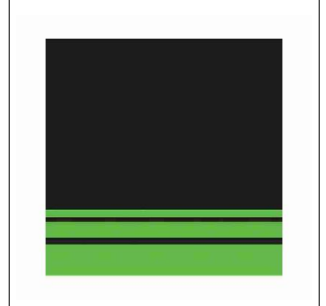

川崎重工業株式会社

26 2019-118815 彩

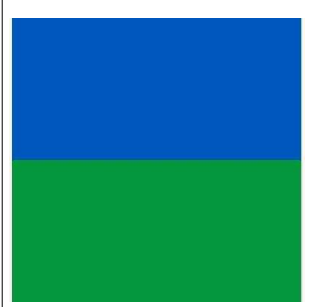

ヨネックス株式会社

27 2020-027238 彩

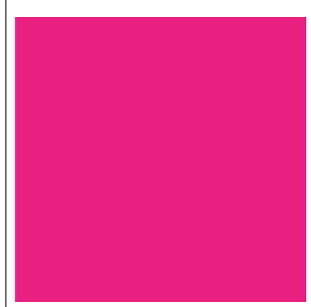

楽天モバイル株式会社

28 2021-103577 多 彩

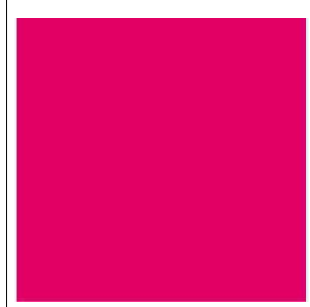

株式会社ノーブルホーム

29 2022-018724 彩



池田 真樹

30 2022-018725 彩

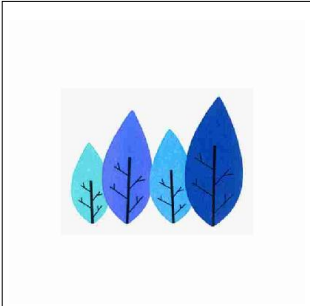

池田 真樹

31 2022-028451 彩 1/2

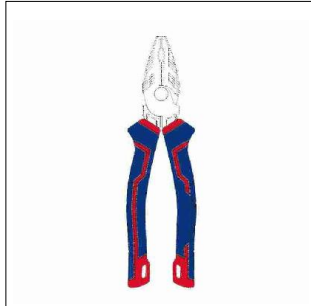

杭州巨星科技股▲分▼有限公司

31 2022-028451 彩 2/2



杭州巨星科技股▲分▼有限公司

32 国0849588 色立



PESCAVIAR, S. L.

33 国1200412 多 彩

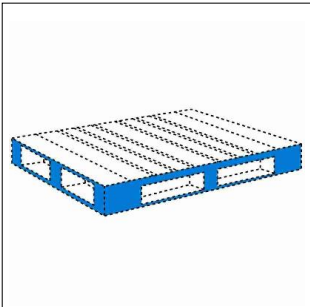

CHEP TECHNOLOGY PTY LIMITED

34 国1614487 彩



Bolder Surgical, LLC